

-

((  
, - , , , .

**0-Б/4**

**: /7-/2-/0**

" :)

: -

2

3,4

7, 252

4

((

16

2022 (

12

((

2022

0-

2( -( ( " - .  
(  
(  
(

1-

<b>-1.</b>	9 5 5 - 5 5 - 5 9 ( 5 Б 9 - 5 - 5 5 5 5 5

-(

1. - ( ( ( ( ( ( ( ( ( ( (

2. ( ( ( ( ( ( ( ( ( ( ( ( ( ( (

3. ( ( ( ( ( ( ( ( ( ( ( ( ( ( (

4. ( ( ( ( ( ( ( ( ( ( ( ( ( ( (

. (

1. ( ( ( ( ( ( ( ( ( ( ( ( ( ( (

2. ( ( ( ( ( ( ( ( ( ( ( ( ( ( (

3. ( ( ( ( ( ( ( ( ( ( ( ( ( ( (

4. - ( ( ( ( ( ( ( ( ( ( ( ( ( ( (

5. ( ( ( ( ( ( ( ( ( ( ( ( ( ( (

6. ( ( ( ( ( ( ( ( ( ( ( ( ( ( (

-(

1. ( ( ( ( ( ( ( ( ( ( ( ( ( ( (

2. ( ( ( ( ( ( ( ( ( ( ( ( ( ( (

3. ( ( ( ( ( ( ( ( ( ( ( ( ( ( (

4. ( ( ( ( ( ( ( ( ( ( ( ( ( ( (

5. ( ( ( ( ( ( ( ( ( ( ( ( ( ( (

6. ( ( ( ( ( ( ( ( ( ( ( ( ( ( (

4

7. ( ) ( ) ( ) ( ) ( )
8. ( ) ( ) ( ) ( ) ( ) ( ) ( ) ( ) ( )
9. ( ) ( ) ( ) ( ) ( ) ( ) ( ) ( ) ( )

4-

)							
-							
1		35	4	0	2	1	28
2		35	2	0	2	1	30
3		35	2	0	1	2	30
4		35	2	0	1	2	30
		4					4
		144	10	0	6	6	122
.							
1		9	1	0	0	0	8
2		12	1	0	2	1	8
3		12	1	0	2	1	8
4	(	9	1	0	0	0	8
5		12	2	0	0	2	8
6		10	1	0	0	1	8
7		13	2	0	2	1	8
8		4	1	0	0	0	3

		27					27
		108	10	0	6	6	86
		252	20	0	12	12	208

5. Б

2-

1. - - 1 (
2. -1 (
3. -1 (
4. .1 (
5. .1 (

3-

1. -
2. -1 ( -
3. -1 ( - (2
4. ( - -
5. -1 ( -1 (

2

1. . 4
1. (
2. (
3. (
4. (
- 4
1. (

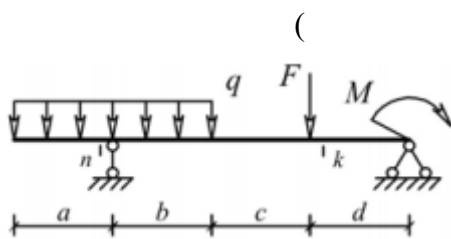

a,	b,	c,	d,	F,	q,	M,
2	3	4	2	4	2	6

2.

( (

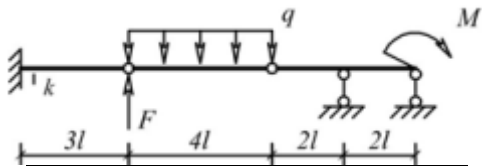

$l,$	$F,$	$q,$	$)$	$M,$
2	4	2		6

4

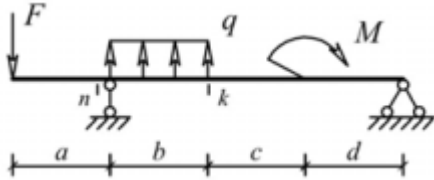

$a,$	$b,$	$c,$	$d,$	$F,$	$q,$	$)$	$M,$
3	3	2	1	14	2		16

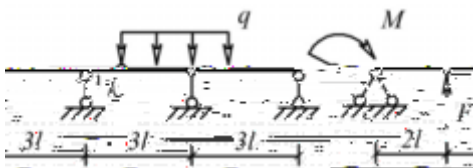

$l,$	$F,$	$q,$	$)$	$M,$
2	12	2		16

2.

4

1.

(

2.

(

3.

(

(

4.

(

4

1.

(

(

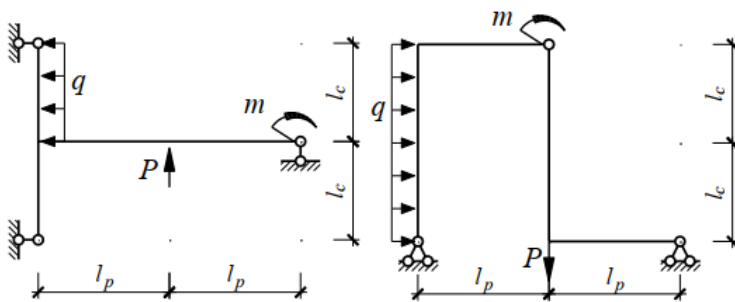

$l_c,$	$l_p,$	$P,$	$q,$	$)$	$M,$
3	2	8	3		10
1,5	2	6	1		5

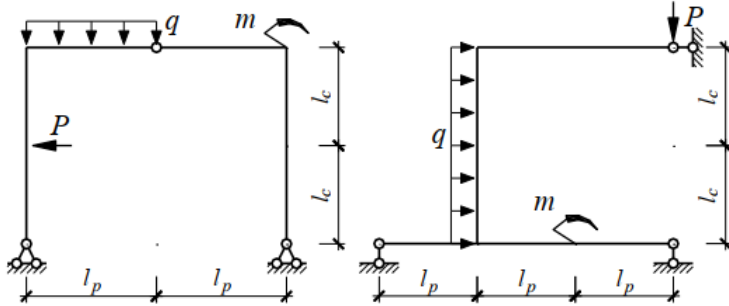

$l_c,$	$l_p,$	$P,$	$q,$	$m,$	$M,$
2,5	2	10	4		15
2	1,5	14	2		15

3.

4

1. (
2. (
3. (
4. (

4

1. (

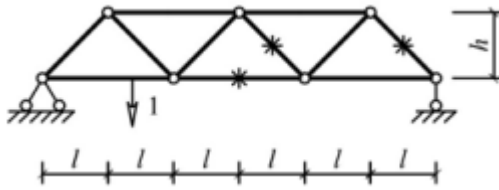

$l,$	$h,$	$F,$
2	2	10

2. (



$l,$	$f,$	$F,$	$q,$
2	4	12	2

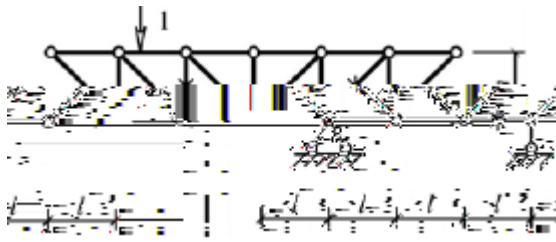

$l,$	$h,$	$F,$
2	1	12

(  
(

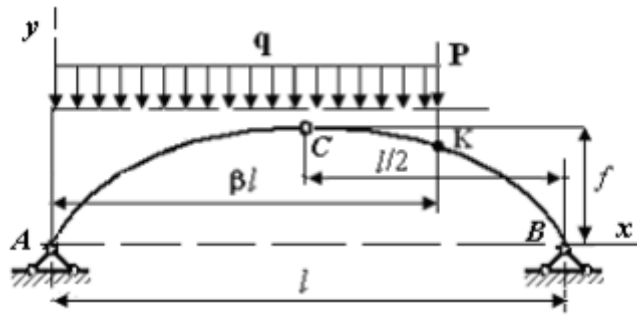

$P=10$     $q=2$     $l=4$     $f=1$     $7$     $1/($

3-  
1.

4

1.  
2.

4

1.

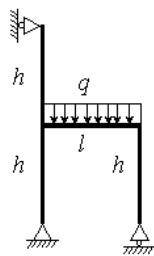

$l,$	$h,$	$q,$
11	2	15

4

(



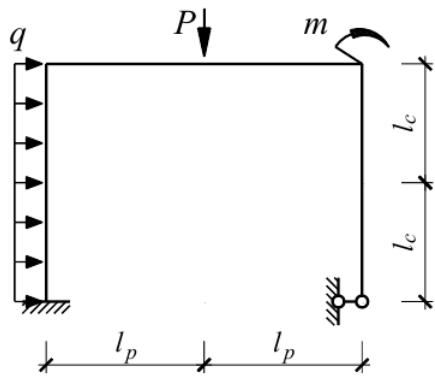

$l_c,$	$l_p,$	$P,$	$q,$	$M,$
2,5	3	30	10	40

2.

4

1. (

2. (

4

1. (

$l_1,$	$l_2,$	$h_1,$	$h_2,$	$q,$	$P_1,$	$P_2,$	$P_3,$	$I_1/I_2$
4	10	3	11	1,1	4	0	0	0,5

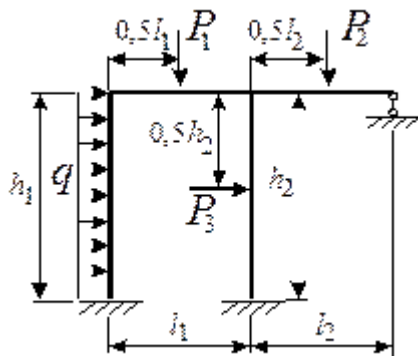

4

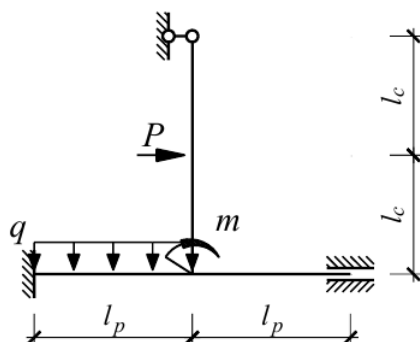

$l_c,$	$l_p,$	$P,$	$q,$	$M,$
1,5	1	10	6	20

3.

4

1.

4

1.

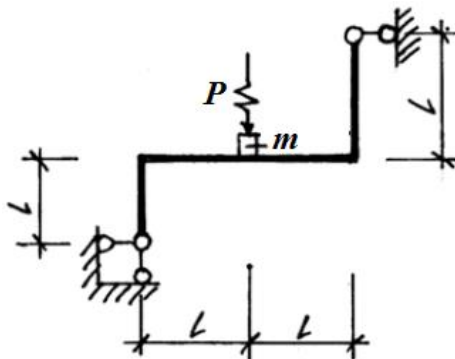

$l = 2 \text{ м}, m = 1000 \text{ кг}, P = P_0 \sin \theta t, P_0 = 2 \text{ кН}, EI = 20000 \text{ кН} \cdot \text{м}^2,$   
 $\theta = 0,8\omega_{min}.$

4

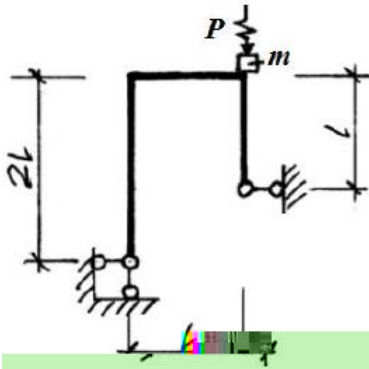

$l=1 \quad m=2000 \quad P = P_0 \sin \theta t, P_0 = 2 \text{ кН}, EI = 20000 \text{ кН} \cdot \text{м}^2, \theta =$   
 $0,8\omega_{min}.$

2-

1. 9

SCADOffice.

B C Office.

4

SCADOffice

(

4

1.

SCADOffice.

2.

(

3. (

4. (

5. (

6. SCADOffice.

7. .

8. (

9. (

2. 9 4 B C Office. SCADOffice  
(

4

1. SCADOffice "

(

2. (

3. (

4. (

3. 9 4 B C Office. SCADOffice  
(

4

1. SCADOffice.

2. .

3. (

4. (

3-

1. 9 4 B C Office.  
SCAD .

4

1) (

2) SCAD.

3) (

4) SCAD

"

5) (

- 6) (
- 7) (
- 8) (
- 9) SCAD.
- 10) (
- 11) SCAD
- 12) .
- 13) (
- 14) (

**2.**

**9**

4

-

- (
- 4
- 1) (
- 2) Excel
- (
- 3) (
- 4) (
- 5) (
- 6) (
- 7) (
- 8) (
- 9) SCAD (

**3.**

**9**

4

**B C Office.**

**B C Office.**

5

- 4
- SCAD.
- 4
- 1) (
- 2) (
- 3) (
- 4) SCAD.

- 5) (
- 6) M; (
- 7) (
- 8) (
- 9) (
- 10) (

4

- 1.
- 2.
- 3.
- 4.

(

2

- 1.
- 2.
- 3.

(

(

(

3

- 1.
- 2.
- 3.
- 4.

(

(

(

(

2

- 1.

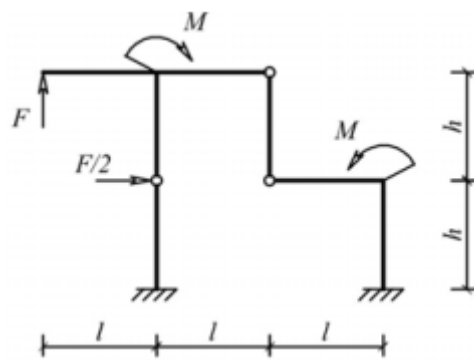

$l,$	$h,$	$F,$	$M,$
2	2,5	10	20

2.

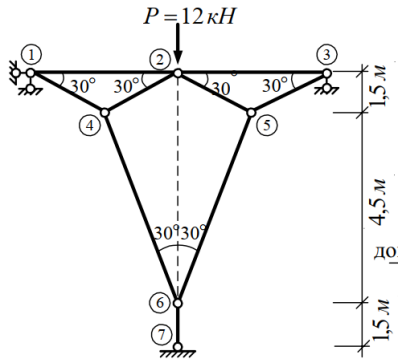

3.

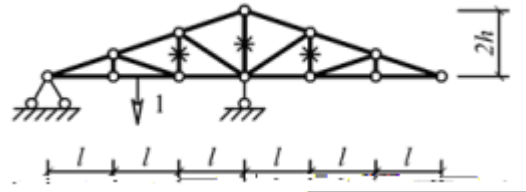
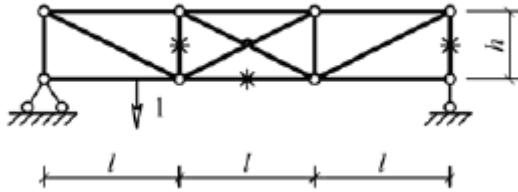

$l,$	$h,$
0,75	1,5
1,75	2

4.

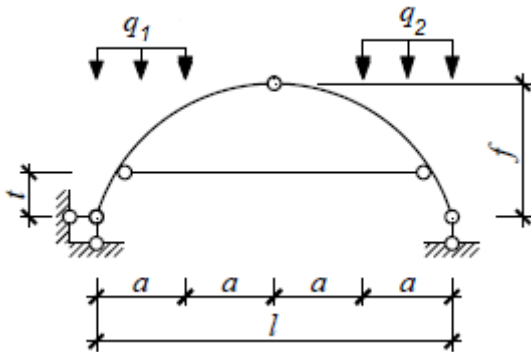

$a,$	$f$	$t$	$q_1$ /	$q_2$ .
1	2	0,5	10	16

5.



К.

3

1.

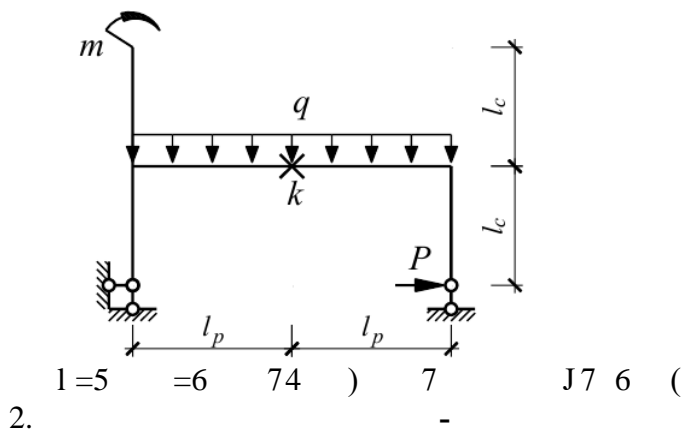

2. (   
 $a = 1 \text{ m}, P = 10 \text{ kH}, q = 4 \text{ kH/m}, [\sigma] = 160 \text{ MPa}.$

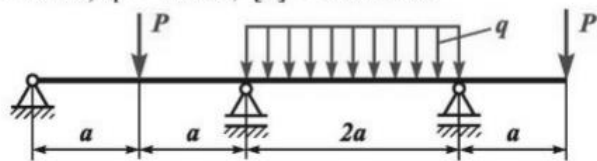

3. (

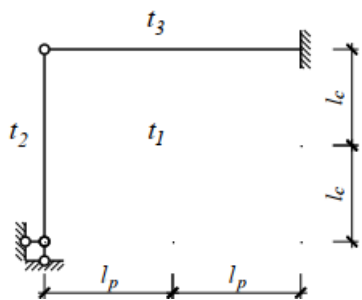

170    7.    t17    t27,    t3--    h7 / (

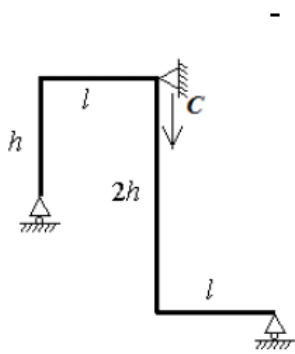

$l,$	$h,$	$c,$
2	3	4

5.

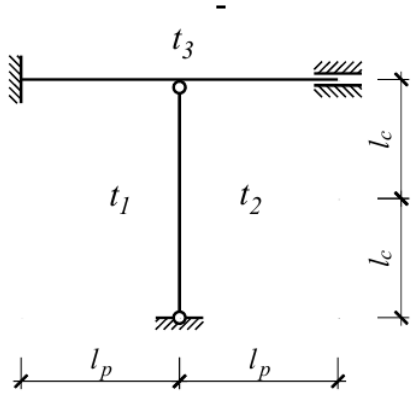

$l_1=1 \quad l_2=1,5 \quad t_1=-2 \quad t_2=15 \quad t_3=$  (

6.

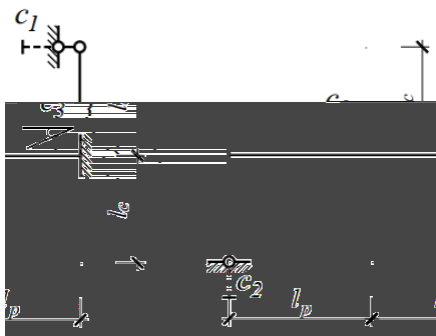

$l_c=1,5 \quad l_p=2 \quad c_1=2 \quad c_2=1 \quad c_3=0,05.$

7.

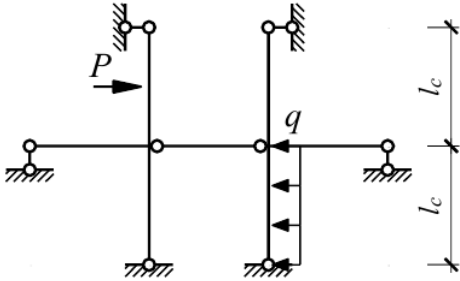

$P=12 \quad q=5 \quad ) \quad l_c=l_p7, \quad ($

8.

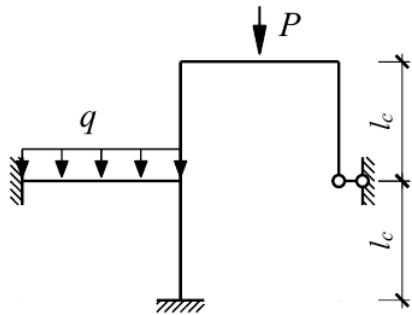

$l_c=3 \quad l_p7, \quad q=1 \quad ) \quad P=8$

9.

(



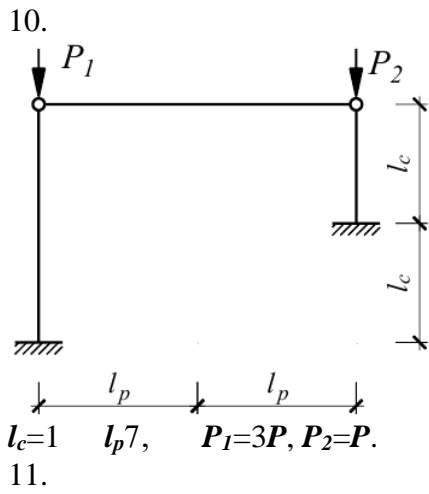

11.

$a = 1 \text{ м}, b = 2 \text{ м}, m_1 = 2m, m_2 = m.$

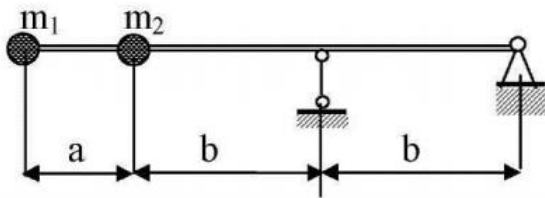

12.

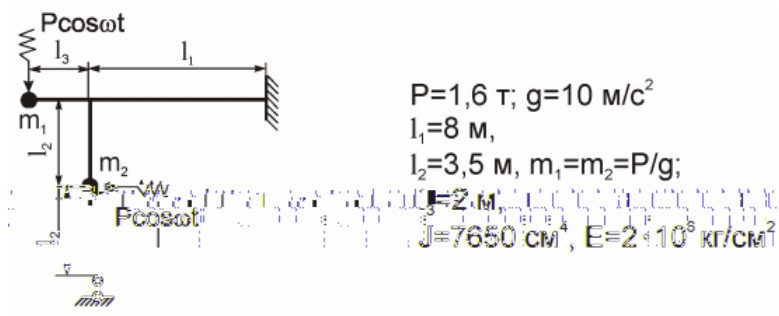

6-  
0( (

-(  
1.

SCAD.

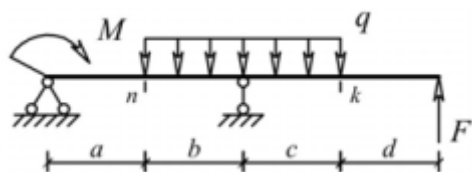

$a,$	$b,$	$c,$	$d,$	$M,$	$F,$	$q,$ /
2	3	4	2	6	4	2

2.

( SCAD.

(

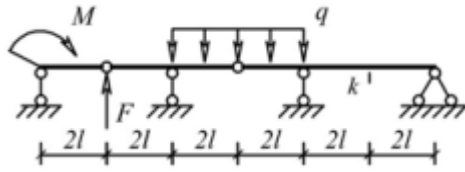

$l,$	$M,$	$F,$	$q,$ /
2	6	4	2

3.

4

- 1)
- 2)
- 3)
- 4)
- 5) Q
- 6)
- 7)

N;  
Q N;

5

SCAD.

P,		b,		q,
				/
12	1	2	24	5

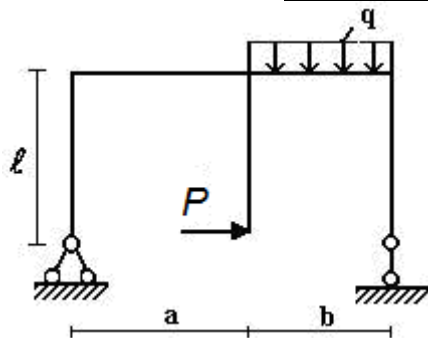

4.

4

- 1)
- 2)
- 3)
- 4)
- 5)
- 6)

5

P

5

5

SCAD;

5

$h,$	$l,$	$P,$
2	2	5

(

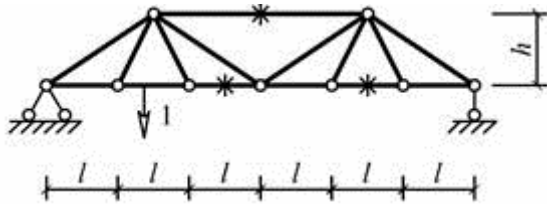

9

8

(

06 (

-

4

1.

(

2.

y

(

(

3.

(

(

4.

(

(

(

.

1.

(

(

2.

(

(

3.

(

(

4.

(

5.

(

6.

(

7.

(

8.

(

(

9.

(

10.

(

11.

(

12.

(

(

13.

(

14.

(

15.

(

(

16.

(

(

17.

(

(

18.

(

(

19.

(

20.

(

(

21.

(

- 22.
- 23.
- 24.
- 25.
- 26.

( ( ( ( ( ( ( (

*Образец экзаменационного билета*

- 1.
- 2.
- 3.

( .  
(  
(  
(

$P_1=3P, P_2=P, P_3=2P, l_p=3, l_c=4$  .

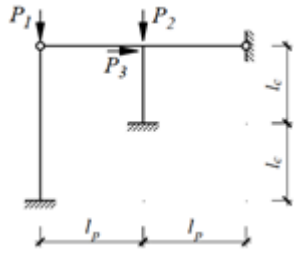

На экзамене

« 4

5  
,  
-  
« 4 5 5  
5  
,  
- 5  
(

«  
(  
(  
« 5  
(

7-

6-0-

- 1.

( ( ( ( ( ( 4 4  
( 2- ( ( ( , , ( /

391 ( " ( ISBN 978-5-534-01124-1. 4 ))  
( URL: <https://urait.ru/bcode/488663>  
2. ( ( : ) ( ( ( ( 5 ( ( ( ( 2

4. <https://infopedia.su/14x333.html> - (
5. <https://rep.bntu.by/> ) ) )111) , 9 7 -
6. <https://dwg.ru/dnl/10438> - ( SCADOffice.

7- -

.,0 ( ( ,

4

- 
- 
- 
- 

5  
5

- - 5

(

.,- ( ( ,

4

- 

- -

328 ( ( ,

4

- 8

SCADOffice.

8-

1. SCAD Office.
2. (